



OXYGEN & SUCTION THERAPY *International Edition*

Flowmeters with Humidifiers | Medical Gas Regulators | Air/Oxygen Blenders | Suction Regulators | Collection Systems



New Products

New Products
New Products



CFM130 Series Click Style Flowmeter

- Available in Oxygen
- Available in 4, 8, 15 and 25 LPM
- Smallest and lightest in the industry
- Smallest increment is 1/32 LPM
- Calibration at 50 or 65 psi
- Encased in an ABS housing
- Easy to read window



230M Series Medical Regulator

Performance driven design for powering ventilators and devices at 120 LPM

- Cleaned for oxygen service per CGA 4.1
- Durable chrome-plated brass body
- 3000 psi maximum inlet pressure
- 1-1/2" diameter UL-listed gauge
- Complies to CGA standards
- Internal relief valve
- Hose barb outlet
- Piston design regulator
- Sintered bronze inlet filter for longer service life
- Easy to read flow rate window



GMX Series Heliox Blenders

- Suitable for use in Emergency Room and ICU where accurate oxygen concentration is required
- Double-ended proportioning valve enables easy adjustment of oxygen concentration from 21% to 100%
- Two-stage pressure-balancing mechanism is adopted to deliver steady oxygen concentration
- Two outlet ports and bleed valve allow a wide range of applications
- Internal bypass and alarm mechanism ensure safe use
- Accuracy: $\pm 3\%$ FS



FMX20 Series Air / Oxygen Mixer

The FMX20 Series Air / Oxygen Mixer is an affordable method to mix air and oxygen for flow and FIO2 control.

- Includes pole mount for easy mounting and transport
- Quiet Operation
- Lower Cost of ownership and maintenance compared to blenders
- Durable and reliable technology



Company Overview

Genstar Technologies Company, Inc (GENTEC®), founded in 1969, is a world class manufacturer of high quality apparatus for high purity, medical and industrial markets.

For the medical industry, GENTEC® provides high quality products such as medical gas flow control systems, regulators, terminal-units, architectural products, and gas alarm systems.

Quality Assurance

GENTEC® manufactures its products in an ISO 13485 certified 396,000 square foot manufacturing facility in order to ensure the highest quality.

Corporate Culture & Management, Training

Gentec strives to instill employee confidence, team spirit, enthusiasm, and self-improvement. The company culture enables employees to provide outstanding customer service, excellent product quality, and continuous technological innovation. Gentec believes in constant improvement to maintain its competitive edge. The company continues to invest considerable time and effort in developing comprehensive training programs to help its employees to fully realize their potential. All new employees take part in a series of training programs within the first two months of their employment.

Core Competency

Gentec's core competency is rooted in the research, development, and production of components, equipment, and systems. The research and development team consists of professionals from various fields, such as chemical engineering, material science, mechanical engineering, electrical engineering, and software programming.

Advanced Laboratorial Testing Devices

The state-of-the-art laboratory features a coordinate measuring system, flow rate measurement system, oxygen concentration monitor, micro-hardness tester, metallurgical microscope, spring testing machine, helium-leak detector, and profilometer. These high-end devices ensure product performance and quality.

**OXYGEN THERAPY**

- 02. Flowmeters with Humidifiers
- 03. Medical Flowmeters
- 05. Flowmeter Accessories
- 06. Nebbulator
- 07. Click Style Flowmeters & Oxygen Supply Manifold
- 08. Humidifiers & Nebulizers
- 09. Flowmeters with Humidifiers & Nebulizers
- 10. Oxygen Flowmeter Regulators with Humidifiers
- 12. Flowmeter Regulators
- 13. Medical Gas Regulators
- 20. Air / Oxygen Blenders, Heliox / Oxygen Blenders
- 23. Air / Oxygen Mixer
- 24. Portable Oxygen Kit, Cylinder Valves,
Refilling Bridge, Cylinder Wrench
- 25. Aluminum Cylinders, Carbon Composite Cylinders
- 26. Medical Hoses
- 27. Medical Hoses with Adapters
- 28. Medical Gas Adapters
- 34. Couplers
- 36. Twin Coupler

**SUCTION THERAPY**

- 37. Suction Regulators
- 40. Venturi Suction Regulator
- 42. Venturi Actuated Suction
- 44. Venturi System, Venturi Vacuum Modules
- 45. Collection Jars
- 48. Wall Slides, Collection Stations & Suction Tubings
- 49. Disposable Bacteria Filters

OXYGEN THERAPY

Flowmeters with Humidifiers

Solutions for Life

Flowmeter

- Polycarbonate outer and inner tubes for maximum durability and service life
- Dual-sided scale, easy to read which covers 180° viewing angles
- Elongated Scale, provides better visual accuracy from 0~5 LPM. The scaling from 0~5 LPM covers half the flowtube
- Back pressure compensated and calibrated at 50 psi or 65 psi



Fittings

- CGA 1240 connection
- Easily connects with humidifiers or nebulizers

Pressure Relief Valve

- Pressure relief valve on cover to vent excess pressure

Filter

- Internal micro filter prevents inhalation of debris
- Reusable

Type of Inlet Adapter

- 00: No adapter (1/8" Female NPT)
- OH: Ohmeda® adapter
- DS: DISS Hex adapter
- DH: DISS Hand-Tight adapter
- CH: Chemetron® adapter
- PB: Puritan-Bennett® adapter
- FS: French (NF S 90-116) adapter
- GS: German (DIN 13260-2) adapter
- BS: British (BS5682-1998) adapter
- JIS: Japanese (JIS T7101) adapter
- SIS: Australian (AS2896) adapter

Control Knob

- Allows steady adjustment of flowrate
- Aluminum construction for durability
- Color Coding available in ISO 32 or NFPA 99



Humidifier

- Our reusable series is designed to be autoclavable up to 121°C during disinfecting procedures
- DISS 1240 inlet adapter
- Polycarbonate bottles are impact resistant for maximum durability and service life



FM897A-15L2-OH
Flowmeter with Humidifier
Oxygen(0-15L) OH inlet adapter

CE
0123

FM197 Series Medical Flowmeters

Oxygen Flowmeters



FM197A-15L-00

Round Tube Anodized Aluminum Body, NFPA 99 Color



FM197B-15L-00E

Round Tube Chrome-plated Brass Body, ISO 32 Color

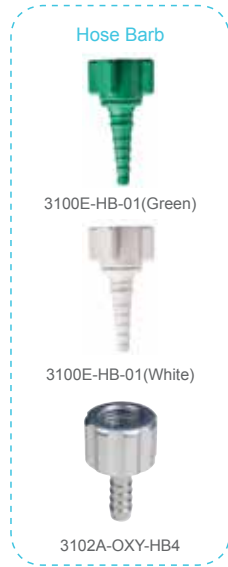

Air Flowmeters



FM197A-15L-00-AIR

Round Tube Anodized Aluminum Body, NFPA 99 Color



FM197B-15L-00E-AIR

Round Tube Chrome-plated Brass Body, ISO 32 Color

Features

- Slim body flowmeter
- Available in anodized aluminum (FM197A) or chrome-plated brass body (FM197B)
- Flow range: 1 LPM, 3 LPM, 6 LPM, 15 LPM, 30 LPM, 50 LPM, 70 LPM
- Polycarbonate tubes for maximum durability
- Back-pressure compensated
- Available in NFPA 99 and ISO 32 colors
- Calibrated at 50 or 65 psi
- CE listed

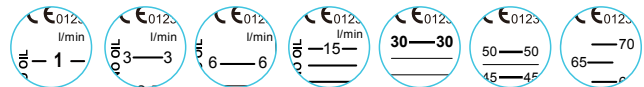

* MRI compatible models available, please add -MRI at the end of the model.

Example: FM197A-15L-00-MRI

** This option shall come with ISO 32 color coding. Please add "E" after liters per minute.

Example: FM197A-15LE-00

*** For ISO 32 colors with 50 psi calibration please add "E" after the connector.

Example: FM197A-15L-00E



Dual Flowmeter with Y Connector



Dual Flowmeter with T Connector



Flowmeter with Power Take Off Connector

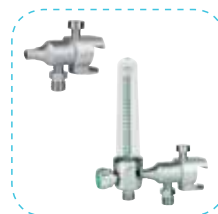

Flowmeter with Rail Clamp (DISS)



Flowmeter with Rail Clamp (Hose Barb)



Flowmeter with 360° Connector

FM293 Series Neonatal, Perinatal and Specialty Flowmeters



FM293-200CC-X

FM293-16L-Q

Features

- Precise flow control
- Range: 200 cc/min, 1LPM, 3LPM, 16LPM, 75LPM, 200cc and 1LPM model are designed for perinatal and neonatal applications where extreme accuracy and very low flow is required.
- Acrylic block construction
- Square shape design for easy reading
- Back pressure compensated and calibrated at 50* psi
- Maximum inlet pressure: 100 psi
- Inlet: 1/8" NPT(F), Outlet: 9/16"-18UNF(M)
- Accuracy: 200 cc/min ~ 3 LPM: $\pm 10\%$ full range
16 ~ 75 LPM: $\pm 5\%$ full range

* Optional calibration for 65 psi available. This option shall come with ISO 32 color coding.

Please add "E" after liters per minute. Example: FM293-16LE-X-XX

For ISO 32 colors with 50 psi calibration please add "E" after the connector. Example: FM293-16L-X-00E

Ordering Information

Model Number	Specifications
FM293-200CC-X	Oxygen flowmeter, Back pressure compensated, 200 cc/min, Inlet connection: 1/8" NPT(F), Outlet connection: 9/16"-18UNF(M)
FM293-1L-X	Oxygen flowmeter, Back pressure compensated, 1 LPM, Inlet connection: 1/8" NPT(F), Outlet connection: 9/16"-18UNF(M)
FM293-3L-X	Oxygen flowmeter, Back pressure compensated, 3 LPM, Inlet connection: 1/8" NPT(F), Outlet connection: 9/16"-18UNF(M)
FM293-16L-X	Oxygen flowmeter, Back pressure compensated, 16 LPM, Inlet connection: 1/8" NPT(F), Outlet connection: 9/16"-18UNF(M)
FM293-75L-X	Oxygen flowmeter, Back pressure compensated, 75 LPM, Inlet connection: 1/8" NPT(F), Outlet connection: 9/16"-18UNF(M)
FM293-16L-Q*	Air flowmeter, Back pressure compensated, 16 LPM, Inlet connection: 1/8" NPT(F), Outlet connection: 9/16"-18UNF(M)
FM293-75L-Q*	Air flowmeter, Back pressure compensated, 75 LPM, Inlet connection: 1/8" NPT(F), Outlet connection: 9/16"-18UNF(M)

Carbon Dioxide Flowmeters



FM197B-12L-00-CO2

Features

- Slim body flowmeter
- Available in anodized aluminum (FM197A-CO2) or chrome-plated brass body (FM197B-CO2)
- Polycarbonate tubes for maximum durability
- Back-pressure compensated
- Flow range: 0~12 LPM
- Calibrated at 50 psi

Heliox Medical Flowmeters



FM197A-12L-S-(Heliox)

Features

- Slim body flowmeter
- Available in anodized aluminum
- Polycarbonate tubes for maximum durability
- Back-pressure compensated
- Flow range: 0~12 LPM
- Calibrated at 50 psi

Ordering Information

Model Number	Specifications
FM197A-12L-00-CO2	Carbon dioxide flowmeter, Back-pressure compensated, 12L, Inlet connection: 1/8" NPT(F)
FM197B-12L-00-CO2	Carbon dioxide flowmeter, Back-pressure compensated, 12L, Inlet connection: 1/8" NPT(F)
FM197A-12L-S-(Heliox)	Heliox flowmeter, Back pressure compensated, 12L, Inlet connection: 1/8" NPT(F)

Flowmeter Accessories



Dual Flowmeter with Y Connector
NFPA 99 Color coding, Inlet: 1/8" NPT(F)



Dual Flowmeter with T Connector
ISO 32 color coding, Inlet: 1/8" NPT(F)



Flowmeter with Power Take Off Connector
NFPA 99 Color coding, Inlet: 1/8" NPT(F), Outlet: DISS



Flowmeter with Rail Clamp (10*25mm)
NFPA 99 Color, Inlet: DISS, 1/4" & 5/16" Hose Barb



Flowmeter with 360° Connector
NFPA 99 Color, Inlet: 1/8" NPT(F), Outlet: DISS



Flowmeter with Nebulizer
ISO 32 color, Inlet: 1/8" NPT(F), Outlet: Hose Barb



Flowmeter Humidifier with FM-PTO Power Take Off, Ohmeda Adapter, and Retaining Wire.



OXYGEN THERAPY

Nebbulator

Solutions for Life

Nebbulator

The Nebbulator is multifaceted and makes itself very convenient and time saving for hospital staff.



FMB197B-15-06L-DH

NFPA 99 Color, Inlet: 1/8" NPT(F), Outlet: Hose Barb

Features

- 50 psi power take off, can be used for multiple products that need 50 psi to power their equipment
- Neb treatments
- Resuscitation bags
- Multiple preset flows
- The Nebbulator is available for use with adult and pediatric flow meters
- The Nebulator Block can be used as a standalone with multiple stand alone settings
- Available in Brass or Aluminum (flowmeter)

Ordering Information

Series	Model Number	Liter Flow
FMB197A-15	FMB197A-15-06L	6 ~ 7 LPM
	FMB197A-15-08L	8 ~ 9 LPM
	FMB197A-15-10L	10 ~ 11 LPM
	FMB197A-15-15L	14 ~ 16 LPM
	FMB197A-15-25L	24 ~ 26 LPM
FMB197B-15	FMB197B-15-06L	6 ~ 7 LPM
	FMB197B-15-08L	8 ~ 9 LPM
	FMB197B-15-10L	10 ~ 11 LPM
	FMB197B-15-15L	14 ~ 16 LPM
	FMB197B-15-25L	24 ~ 26 LPM

Nebulator without Flowmeter

Model Number	Liter Flow
FB-06L-00	6 ~ 7 LPM
FB-08L-00	8 ~ 9 LPM
FB-10L-00	10 ~ 11 LPM
FB-15L-00	14 ~ 16 LPM
FB-25L-00	24 ~ 26 LPM

Add OH (Ohmeda), DS (DISS), CH (Chemetron), DH (DISS Hand-Tight), DS (DISS Nut-Nipple) or PB (Puritan-Bennett) to the end of the model number - eg, FMB197B-15-06L-DH

Click Style Flowmeter

Features

- Available in Oxygen
- Available in 4, 8, 15 and 25 LPM
- Smallest and lightest in the industry
- Smallest increment is 1/4 LPM
- Calibration for 50* psi
- Encased in an ABS housing
- Easy to read window

* Calibration for different pressures available upon request



CFM130-15L-OH
Click Style Flowmeter with
Ohmeda inlet adapter



CFM130-25LE-XX
Click Style Flowmeter without
inlet adapter, ISO 32 color

Ordering Information

Model Number (USA)	Model Number (ISO)	Flow Rate (LPM)
CFM130-4L-XX	CFM130-4LE-XX	0, 0.25, 0.5, 0.75, 1, 1.25, 1.5, 2, 2.5, 3, 3.5, 4
CFM130-8L-XX	CFM130-8LE-XX	0, 0.5, 1, 1.5, 2, 2.5, 3, 4, 5, 6, 7, 8
CFM130-15L-XX	CFM130-15LE-XX	0, 0.5, 1, 2, 3, 4, 5, 6, 8, 10, 12, 15
CFM130-25L-XX	CFM130-25LE-XX	0, 0.5, 1, 2, 3, 4, 5, 6, 8, 10, 15, 25

* XX: Inlet adapter (00, OH, DS, DH, CH, PB, FS, GS, BS, JIS, SIS)
Example: CFM130-15L-OH, CFM130-8LE-BS

Oxygen Supply Manifold



Features

- Economical and practical
- For EMS and mass casualty situations where multiple patients require oxygen simultaneously
- Consistent pressure

OXYGEN THERAPY

Humidifiers & Nebulizers

Solutions for Life

Humidifiers



7100R
(Volume 200 ml)

New



7100R-L
(Volume 300 ml)



7200R
(Volume 140 ml)



7300R
(Volume 350 ml)

CE
0123

Features

- Reusable
- Polycarbonate bottles are impact resistant for maximum durability and service life
- Pressure relief valve on cover to vent excess pressure
- Designed to be autoclavable up to 121°C during disinfecting procedures (Models 7200R and 7300R)
- DISS 1240 inlet connection
- CE listed



Nebulizers

Features

- Reusable
- Polycarbonate bottles are impact resistant for maximum durability and service life
- Relief valve with whistle alert
- DISS 1240 inlet connection



7700R
(Volume 300 ml)



Flowmeters with Humidifiers / Nebulizers

Humidifiers & Nebulizers	Flowmeters				
					
	FM197A	FM197B	FM197A-AIR	FM197B-AIR	CFM130
 7100R	FM897A-6L1-XX FM897A-3L1-XX	FM897B-6L1-XX FM897B-3L1-XX	FM897A-6L1-XX-AIR FM897A-3L1-XX-AIR	FM897B-6L1-XX-AIR FM897B-3L1-XX-AIR	CFM830-8L1-XX CFM830-4L1-XX
 7100R-L	FM897A-15L1L-XX	FM897B-15L1L-XX	FM897A-15L1L-XX-AIR	FM897B-15L1L-XX-AIR	CFM830-25L1L-XX CFM830-15L1L-XX
 7200R	FM897A-6L2-XX FM897A-3L2-XX	FM897B-6L2-XX FM897B-3L2-XX	FM897A-6L2-XX-AIR FM897A-3L2-XX-AIR	FM897B-6L2-XX-AIR FM897B-3L2-XX-AIR	CFM830-8L2-XX CFM830-4L2-XX
 7300R	FM897A-15L3-XX	FM897B-15L3-XX	FM897A-15L3-XX-AIR	FM897B-15L3-XX-AIR	CFM830-25L3-XX CFM830-15L3-XX
 7700R	FM897A-6L7-XX FM897A-15L7-XX	FM897B-6L7-XX FM897B-15L7-XX	-	-	CFM830-15L7-XX CFM830-8L7-XX CFM830-4L7-XX

* XX: Inlet adapter (00, OH, DS, DH, CH, PB, FS, GS, BS, JIS, SIS). Example: FM897A-15L3-OH

Ordering Information

Ex: FM897	A	- 15L	1	- OH
Series Number	Flowmeter Body Material	Flowmeter Rating	Humidifiers or Nebulizers	Inlet Connection
FM897: Oxygen Flowmeters with Humidifiers or Nebulizers FM897-AIR: Air Flowmeters with Humidifiers or Nebulizers	A: Anodized Aluminum B: Chrome-plated Brass	3L: 3L 6L: 6L 15L: 15L	1: 7100R(200ml) 1L: 7100R-L(300ml) 2: 7200R(140ml) 3: 7300R(350ml) 7: 7700R(300ml)	OH: Ohmeda® adapter (male) DS: DISS Hex adapter (male) DH: DISS Hand-Tight adapter (male) NS: NIST adapter CH: Chemetron® adapter (male) PB: Puritan-Bennett® adapter (male) FS: French (NF S 90-116) adapter (male) GS: German (DIN 13260-2) adapter (male) BS: British (BS5682-1998) adapter (male) JIS: Japanese Style adapter (male) SIS: Australian (AS2896) adapter (male)
CFM830: CFM130 Flowmeters with Humidifiers or Nebulizers	None	4L: 3L 8L: 6L 15L: 15L 25L: 25L		

OXYGEN THERAPY

Oxygen Flowmeter Regulators with Humidifiers

Solutions for Life

Oxygen Flowmeter Regulators with Humidifiers

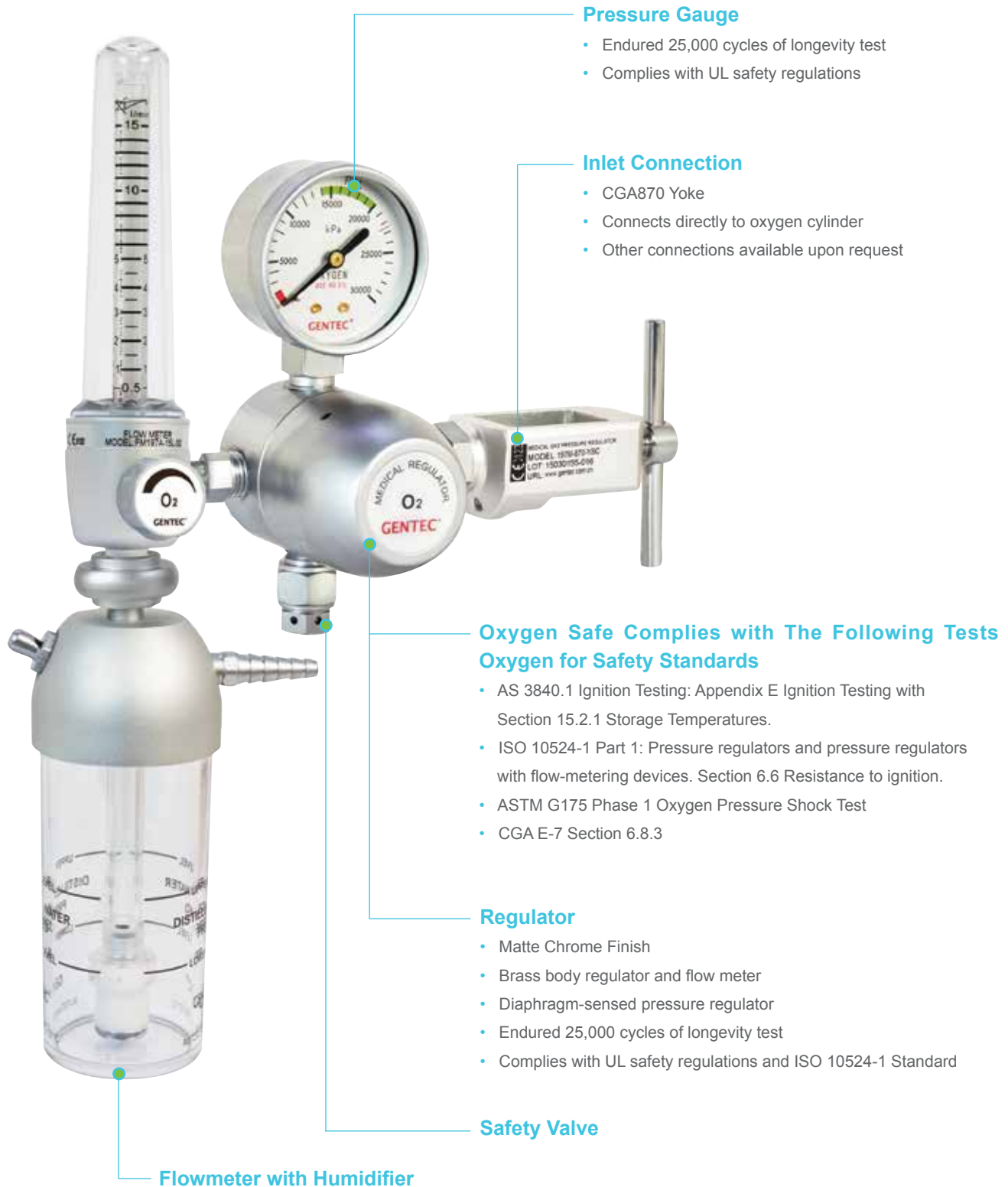

Oxygen Flowmeter Regulators with Humidifiers



891M

- Chrome-plated brass body regulator
- Piston-type regulator design
- Back-pressure compensated flowmeter
- For use with oxygen cylinder
- NFPA 99 Color
- Different style gauges available



895M

- Chrome-plated brass body regulator
- Diaphragm-type design
- Back-pressure compensated flowmeter
- For use with oxygen cylinder
- NFPA 99 Color
- Different style gauges available



897M

- Matte-chrome brass body regulator
- Diaphragm-type design
- Back-pressure compensated flowmeter
- For use with oxygen cylinder
- ISO 32 color
- Different style gauges available



Ordering Information

Model Number	Delivery Flow	Inlet Connection	Working Pressure*	Pressure Gauge	Inlet Pressure
891M-15L	0-15L	CGA 540 Nut	50 psi	1.5"	3000 psi
895M-15L	0-15L	CGA 540 Nut	50 psi	2"	3000 psi
897M-15L	0-15L	CGA 540 Nut	50 psi	2"	3000 psi
891M-15LH	0-15L	CGA 540 Hand-Tight	50 psi	1.5"	3000 psi
895M-15LH	0-15L	CGA 540 Hand-Tight	50 psi	2"	3000 psi
897M-15LH	0-15L	CGA 540 Hand-Tight	50 psi	2"	3000 psi
891M-15LY	0-15L	CGA 870 Yoke	50 psi	1.5"	3000 psi
895M-15LY	0-15L	CGA 870 Yoke	50 psi	2"	3000 psi
897M-15LY	0-15L	CGA 870 Yoke	50 psi	2"	3000 psi
891M-15L-BS	0-15L	BS 341 NO.3	50 psi	1.5"	3000 psi
895M-15L-BS	0-15L	BS 341 NO.3	50 psi	2"	3000 psi
897M-15L-BS	0-15L	BS 341 NO.3	50 psi	2"	3000 psi
891M-15L-BSH	0-15L	BS 341 NO.3 Hand-Tight	50 psi	1.5"	3000 psi
895M-15L-BSH	0-15L	BS 341 NO.3 Hand-Tight	50 psi	2"	3000 psi
897M-15L-BSH	0-15L	BS 341 NO.3 Hand-Tight	50 psi	2"	3000 psi
891M-15L-DIN	0-15L	DIN 477 NO.9	50 psi	1.5"	3000 psi
895M-15L-DIN	0-15L	DIN 477 NO.9	50 psi	2"	3000 psi
897M-15L-DIN	0-15L	DIN 477 NO.9	50 psi	2"	3000 psi

* Optional calibration for 65 psi available.

Oxygen Flowmeter Regulators



191M-15L
Piston-type Regulator with Flowmeter and CGA540 Nut and Nipple Inlet, NFPA 99 Color



195M-15L
Diaphragm-type Regulator with Flowmeter and CGA540 Nut and Nipple Inlet, NFPA 99 Color



197M-15L-BS
Diaphragm-type Regulator with Flowmeter and BS 341 no.3 Nut and Nipple Inlet, ISO 32 Color

Features

- Back-pressure compensated flowmeters
- 3000 psi maximum inlet pressure
- Flow range: 0~15 LPM, 0~70 LPM
- For use with oxygen cylinders
- Meets ignition testing for oxygen service
- CE listed

* Optional calibration for 65 psi available.

Ordering Information

Model Number	Delivery Flow	Inlet Connection	Working Pressure	Body Material
191M-15L	0-15 LPM	CGA 540	50 psi	Chrome-plated Brass
191M-15LY	0-15 LPM	CGA 870 Yoke	50 psi	
195M-15L	0-15 LPM	CGA 540	50 psi	Chrome-plated Brass
195M-15LY	0-15 LPM	CGA 870 Yoke	50 psi	
195M-70L	0-70 LPM	CGA 540	50 psi	Matte Chrome-plated Brass
197M-15L	0-15 LPM	CGA 540	50 psi	
197M-15LY	0-15 LPM	CGA 870 Yoke	50 psi	

* International connections optional: BS 341 no.3 add "-BS", DIN 477 no.9 add "-GS", JIS 22-R add "-JS"
Example: 191M-15L-DIN for DIN 477 no.9 inlet connection

Heliox Flowmeter Regulators

Heliox Flowmeter Regulators are designed for use in respiratory urgent care and respiratory treatment purposes. The GENTEC® Heliox Flowmeter Regulator is calibrated for 80/20 heliox (80% helium / 20% oxygen). Use our heliox flowmeter regulator to avoid the conversion errors that occur when using standard oxygen or air flowmeters.



197M-HX-12L
Heliox Flowmeter Regulator with CGA280 Inlet

Features

- Flowmeter calibrated for heliox 80/20 mixture
- Back-pressure compensated
- Polycarbonate tubes for longer service life
- Chrome-plated brass body
- Maximum inlet pressure: 3000 psi
- 2" pressure gauge for easy reading

Ordering Information

Model Number	Delivery Flow	Inlet Connection	Working Pressure	Body Material
197M-HX-12L	0-12 LPM	CGA 280	50 psi	Matte Chrome-plated Brass

* International connections optional: BS 341 no.3 add "-BS", DIN 477 no.9 add "-GS", JIS 22-R add "-JS"
Example: 197M-HX-12L-DIN for DIN 477 no.9 inlet connection

195M Series Medical Gas Regulators

Features

- Regulator for medical gas supply from cylinder
- Chrome-plated brass body
- 3000 psi maximum inlet pressure
- Outlet pressure: 30 ~ 90 psi
- 1-1/2" diameter gauges
- Internal relief valve
- Diaphragm-type regulator design
- Sintered inlet filter for longer service life
- Dual scale pressure gauge: psi and kPa
- Adjustable setting
- CE listed



195M -540D
Diaphragm-type Regulator without Flowmeter,
with CGA540 Nut and Nipple Inlet



195M -540D-FOH
Diaphragm-type Regulator without Flowmeter,
with CGA540 Nut and Nipple Inlet and Ohmeda
Coupler



195MG-8-870
Flow gauge regulator with CGA870 yoke inlet



195MA-15-870
Flow gauge regulator with CGA870 yoke inlet

Ordering Information

Ex:	195M	G	- 15	- CGA540
	Series	Inlet Type	Flow Gauge	CGA Connector
	195M	None: Standard G: With outlet connector and pressure gauge A: Axial inlet	None: Without flow gauge 5: 5L 8: 8L 15: 15L	CGA540 CGA580

OXYGEN THERAPY

Medical Gas Regulators

Solutions for Life

195MG-100P-540 Series Medical Gas Regulator



195MG -100P-540
Diaphragm-type Regulator without Flowmeter,
with CGA540 Nut and Nipple Inlet

CE
0123

Features

- Chrome-plated brass body
- 3000 psi maximum inlet pressure
- 1-1/2" diameter gauges
- Internal relief valve
- Diaphragm-type regulator design
- Sintered inlet filter for longer service life
- Dual scale pressure gauge: psi and kPa
- Adjustable setting: 0 ~ 100 psi

195MZ Series Medical Gas Regulator

Features

- Regulator for medical gas supply from terminal
- Chrome-plated brass body
- 200 psi maximum inlet pressure
- Outlet pressure: 0 ~ 40 psi
- 2" diameter gauges
- Internal relief valve
- Diaphragm-type regulator design
- Sintered inlet filter for longer service life
- Dual scale pressure gauge: psi and kPa
- Adjustable setting



195MZ-O2-GS-HB4
Diaphragm-type regulator without flowmeter,
with hose barb and German DIN inlet

Ordering Information

Ex: 195MZ	- O2	- GS	- HB4
Series	Gases	Inlet Connection	Outlet Connection
195MZ	O2: Oxygen AIR: Medical Air N2O: Nitrous Oxide CO2: Carbon Dioxide N2: Nitrogen	OH: Ohmeda® adapter (male) DH: DISS Hand-Tight adapter (male) CH: Chemetron® adapter (male) FS: French (NF S 90-116) adapter (male) DIN: German (DIN 13260-2) adapter (male) BS: British (BS5682-1998) adapter (male) JIS: Japanese Style adapter (male) SIS: Australian (AS2896) adapter (male)	DS: DISS Hex adapter (male) NS: NIST adapter PB: Puritan-Bennett® adapter (male) HB4: 1/4" hose barb HB5: 5/16" hose barb FDS: DISS outlet

230 Series Flow Gauge Regulator

Features

- Chrome-plated brass body
- 3000 psi maximum inlet pressure
- 1-1/2" diameter gauges
- Internal relief valve
- Piston-type regulator design
- Sintered inlet filter for longer service life
- Dual scale pressure gauge: psi and kPa
- With choice of DISS connection
- Hose barb adapter included
- Fixed orifice



230M-15-CGA540-M



230M-15-CGA870



230M-15-CGA540-L



230M-15-CGA870



Ordering Information

Ex:	230M	- 15	- 540	- M
	Series	Flow Settings	CGA Connector	Inlet Connector Length
	230M	5: 5 L 8: 8 L 15: 15 L 45: 45 L 50 P: 50 psi	540: CGA540 870: CGA870 See table below	None: Standard M: 2" Length L: 6" Length

Gas Connection Table

Gas	CGA (Screw Thread)	CGA (Hand-Tight)	CGA (Yoke)	DIN (477)	BS (Screw Thread)(341)	BS (Hand-Tight)(341)
O ₂	BP-CGA540	BP-CGA540H	CGA870-2	BP-DIN477-9	BP-BS341-3	BP-BS341-3H
AIR	BP-CGA346	BP-CGA346H	CGA950-2	BP-DIN477-13	BP-BS341-3	BP-BS341-3H
He	BP-CGA580	-	CGA930-2	-	-	-
NE	BP-CGA580	-	-	-	-	-
N ₂	BP-CGA580	-	CGA960-2	BP-DIN477-10	-	-
N ₂ O	BP-CGA326	BP-CGA326H	CGA910-2	BP-DIN477-11	-	-
CO ₂	BP-CGA320	-	CGA940-2	BP-DIN477-6	BP-BS341-8	-
O ₂ +N ₂ O	BP-CGA280	-	CGA965-2	-	-	-
He ₂ +O ₂	BP-CGA280	-	CGA890-2 CGA930-2	-	-	-

* We offer various international connections, please inform us of your connection requirement if it is not listed above.

OXYGEN THERAPY

Medical Gas Regulators

Solutions for Life

230M Series Medical Gas Regulators



230M-15L2

Click-Style Regulator with Hose Barb Outlet,
two DISS Outlets and CGA 540 Inlet



230M-15LY2

Click-Style Regulator with Hose Barb Outlet,
two DISS Outlets and CGA 870 Yoke Inlet

Features

- Performance driven design for powering ventilators and devices at 120 LPM
- Cleaned for oxygen service per CGA 4.1
- Durable chrome-plated brass body
- 3000 psi maximum inlet pressure
- 1/2" diameter UL-listed gauge
- Complies to CGA standards
- Internal relief valve
- Hose barb outlet with optional DISS, SIS, DIN or BS
- Powertake off connections
- Sintered bronze inlet filter
- Top view easy to read flow rate window
- Additional Knob view flow rate window
- Meets ignition testing for oxygen service



230M-15LBS2

Click-Style Regulator with Hose Barb Outlet,
two DISS Outlets and BS Inlet

284MA, 285MA / 287MA, 288MA Series Aluminum Medical Gas Regulators



284MA-15L1

Click-Style Regulator with Hose Barb, one DISS Power Take Off Outlet and CGA 540 Nut and Nipple Inlet



284MA-15LBSH1-FOH

Click-Style Regulator with Hose Barb, one Ohmeda Coupler and BS341#3 Cylinder Connection



285MA-8LY

Mini Click-Style Regulator with Hose Barb Outlet



287MA-15LY

Click-Style Regulator with Hose Barb Outlet and CGA 950 Yoke Inlet



288MA-8LY

Mini Click-Style Regulator with Hose Barb Outlet



284MA-15LY

Click-Style Regulator with Hose Barb Outlet and CGA 870 Yoke Inlet

Features

- Available in Oxygen (284MA, 285MA Series) or Medical Air (287MA, 288MA Series)
- Aluminum body with brass high pressure chamber
- 3000 psi maximum inlet pressure
- 1-1/2" diameter UL-listed gauge
- Complies to CGA standards
- Internal relief valve
- Hose barb outlet
- Piston-type design regulator
- Sintered bronze inlet filter for longer service life
- Easy to read flow rate window



287MA-15L-BS

Click-Style Regulator with Hose Barb, BS Cylinder Connection

OXYGEN THERAPY

Medical Gas Regulators

Solutions for Life

286 Series Brass Medical Gas Regulators



286MB-15LY2
Click-Style Regulator with Hose Barb Outlet,
two DISS Outlets and CGA 870 Yoke Inlet



286MB-15LBS1-FBS
Click-Style Regulator with hose barb outlet,
BS 5682 coupler outlet and BS341#3 inlet

Features

- Available in Oxygen
- Chrome-plated brass body
- 3000 psi maximum inlet pressure
- 1-1/2" diameter UL-listed gauge
- Complies to CGA standards
- Internal relief valve
- Hose barb outlet
- Piston design regulator
- Sintered bronze inlet filter for longer service life
- Easy to read flow rate window
- Meets ignition testing for oxygen service
- Pre-set: 50 psi, options: 58 or 65 psi

Flow Rate

Flow Settings	Flow Rate (LPM)
4L	0, 0.25, 0.5, 0.75, 1, 1.25, 1.5, 2, 2.5, 3, 3.5, 4
8L	0, 0.5, 1, 1.5, 2, 2.5, 3, 4, 5, 6, 7, 8
15L	0, 0.5, 1, 2, 3, 4, 5, 6, 7, 8, 10, 15
25L	0, 0.5, 1, 2, 4, 5, 6, 8, 10, 15, 20, 25

Ordering Information

Ex:	230M	- 4L	Y	2	- FBS
	Series	Flow Settings (LPM)	Inlet Connector	DISS Outlet (s)	Coupler Outlet (s)
	230M	4L	None: CGA540	None: without DISS Outlet	None: without coupler
	284MA	8L	Y: CGA870	1: with one DISS Outlet	FOH: Ohmeda® coupler
	285MA	15L	BS: BP-BS341-3	2: with two DISS Outlets	FDS: DISS hex coupler
	286MB	25L	BSH: BP-BS341-3H	D: DISS outlet replacing hose barb	FDH: DISS Hand-Tight coupler
	287MA	2CK: None, Pre-set: 50 psi		FFS: French (NF S 90-116) coupler
	288MA				FGS: German (DIN 13260-2) coupler
					FBS: British (BS5682-1998) coupler
					FJIS: Japanese style coupler
					FSIS: Australian (AS2896) coupler

193M Series Regulators



193M-870

193M

Features

- Available in O₂, AIR, N₂O and CO₂
- Chrome-plated brass body, 2" diameter gauges
- 3000 psi maximum inlet pressure
- External relief valve
- Meets ignition testing for oxygen service
- Diaphragm-sensed pressure regulator
- Sintered inlet filter for longer service life
- Dual scale pressure gauge: psi and kPa
- Endured over 25,000 cycles of longevity testing
- RoHS compliant, CE listed
- Suitable for ventilators, anesthesia machines, etc

197M Series Regulators



197M-870-YSC

Features

- Oxygen SIS outlet connection
- Color coded pressure gauge
- Regulator Inlet Connection: Pin-indexed CGA870 Yoke
- Maximum Inlet Pressure: 20,000 kPa
- Delivery Pressure: 400 kPa (Fixed)
- With safety relief valve
- For use with oxygen cylinders
- 4 bar pre-set pressure

152M Series Medium Duty Regulators



152MX-80

Medium Duty Single-stage Regulator

Features

- Chrome-plated brass body and housing cap
- Delrin cap bushing for smooth adjustments
- Self re-seating external pressure relief valve
- Sintered bronze inlet filter
- Stem-type seat assembly for more reliable performance
- Max. Inlet Pressure: 3000 psi
- Max. Delivery Pressure: 80, 125 psi
- 2" gauges for easy reading
- 2" diaphragm
- Suitable for ventilators, anesthesia machines, etc

155M Heavy Duty Manifold Regulator



155MX-200

Heavy Duty Single-stage Regulator

Features

- Single-stage construction
- Forged brass body and housing cap
- Delrin cap bushing for smooth adjustments
- Self re-seating external pressure relief valve
- Sintered bronze inlet filter
- 2-1/2" gauges for easy reading
- 3-1/4" diaphragm
- Conforms to CGA E-4 standard for gas pressure regulators

255L Heavy Duty Oxygen Line Regulator



255L-200

Heavy Duty EPDM Regulator

Features

- Forged brass body
- Cleaned for oxygen service per CGA 4.1
- EPDM Seats and Diaphragm
- Up to 120 m³/hr flow
- Medical pipeline regulator

OXYGEN THERAPY

Air / Oxygen Blenders, Heliox / Oxygen Blenders

Solutions for Life

Air / Oxygen Blenders, Heliox / Oxygen Blenders

Durable Housing

- The curved surface is smooth and easy to clean

Control Knob

- Ergonomic design provides smooth and easy control
- Easy adjustment of oxygen concentration from 21% to 100%

Primary Outlet

- CGA V-5 1240 (DISS) connector
- With check valve
- Compatible with GENTEC® flowmeter

Color Coding

- Available in both NFPA 99 and ISO 32 Color Code



Oxygen Inlet

- USA standard: CGA V-5 1240 (DISS) oxygen connector
- ISO standard: ISO 18082 A8 (NIST) oxygen connector
- Compatible with GENTEC® medical hose

Slide Mount

- Easily mounted with the mounting bracket



Auxiliary Outlet

- CGA V-5 1240 (DISS) connector
- With check valve
- Compatible with GENTEC® flowmeter

Air Inlet (Air / Oxygen Blenders)

- USA standard: CGA V-5 1160 (DISS) air connector
- ISO standard: ISO 18082 A3 (NIST) air connector
- Compatible with GENTEC® medical hose
- Inlet Pressure: 40.6 ~ 87 psi
- Differential Pressure: ≤ 17.4 psi

He/O2 Inlet (Heliox Blender)

- USA standard: CGA V-5 1180 (DISS) He/O2 connector
- ISO standard: ISO 18082 B14 (NIST) He/O2 connector
- Compatible with GENTEC® medical hose
- Inlet Pressure: 40.6 ~ 87 psi
- Differential Pressure: ≤ 17.4 psi



Features

- Suitable for use in Emergency Room and ICU where accurate oxygen concentration is required
- Double-ended proportioning valve enables easy adjustment of oxygen concentration from 21% to 100%.
- Two-stage pressure-balancing mechanism is adopted to deliver steady oxygen concentration.
- Two outlet ports and bleed valve allow a wide range of applications
- Internal bypass and alarm mechanism ensure safe use.
- Accuracy: $\pm 3\%$ FS

Air/Oxygen Blender without Flowmeter



Air/Oxygen Blender with Primary Flowmeter



Air/Oxygen Blender with Auxiliary Flowmeter



Air/Oxygen Blender with Primary and Auxiliary Flowmeter



Air/Oxygen Blender with Dual Primary and Single Auxiliary Flowmeter



Ordering Information

GMX30	U	- Air/O2-	NS	-	P15	A6	-	OH	3	C	-	D20
Model Number	Color Code	Gas Code	Default Connections		Primary Flowmeter	Auxiliary Flowmeter		Hose Assemblies	Hose Length	Condensation Trap		Clip
GMX30 (0~30 LPM)	U: NFPA 99 (USA) E: ISO 32	Air/O2 He80: 70%He+30%O2 He70: 80%He+20%O2	Null: Default Connections* DS: ISO 32 Color Code with DISS Inlet Connector NS: NFPA 99 Color Code with NIST Inlet Connector		Null: No Flowmeter P0: Plugged Port P1: 0~1 LPM P3: 0~3 LPM P6: 0~6 LPM P15: 0~15 LPM P25: 0~25 LPM P50: 0~50 LPM P70: 0~70 LPM	Null: No Flowmeter A0: Plugged Port A1: 0~1 LPM A3: 0~3 LPM A6: 0~6 LPM A15: 0~15 LPM A25: 0~25 LPM A50: 0~50 LPM		Null: None OH: Ohmeda® Adapter FS: 3105 (FS) Series Adapter GS: 3106 (GS) Series Adapter BS: 3107 (BS) Series Adapter JIS: 3108 (JIS) Series Adapter SIS: 3109 (SIS) Series Adapter	1: 1 M 2: 2 M 3: 3 M 4: 4 M 5: 5 M 6: 6 M	Null: None C: With Condensation Trap		Null: None D20: Φ8~20 Rod D30: Φ10~30 Rod D40: Φ12~40 Rod S25: 25X10 Rail

OXYGEN THERAPY

Air / Oxygen Blenders, Heliox / Oxygen Blenders

Solutions for Life

Use Case Diagram

Blender Application with oxygen and air cylinders as gas source.

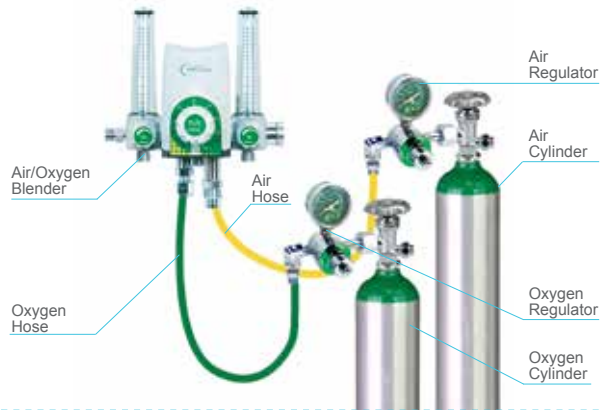

Blender Application with central oxygen and air as gas source and optional condensation trap.

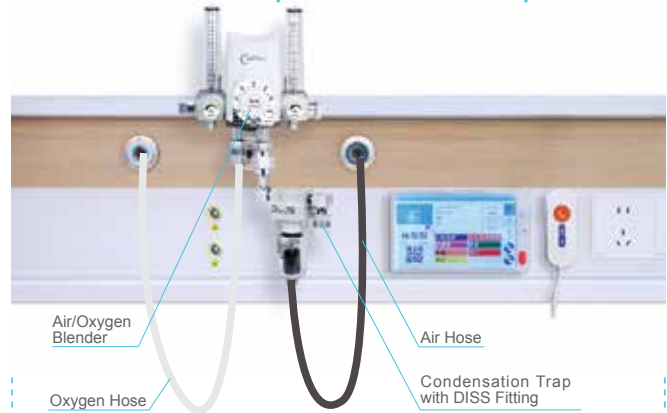

Accessories

Flowmeter



Hose Assemblies (USA)



Hose Assemblies (ISO)



Wall Slide



Condensation Trap



Adapter (Electroplate)



USA Hose Barb (Plastic)



ISO Hose Barb (Plastic)



Hose Barb (Electroplate)



Air / Oxygen Mixer

The FMX20 Series Air / Oxygen Mixer is an affordable method to mix air and oxygen for flow and FIO₂ control.

Features

- Includes pole mount for easy mounting and transport
- Quiet Operation
- Lower Cost of ownership and maintenance compared to blenders
- Durable and reliable technology

Parameters

Flowmeter Accuracy	4.0
Filtration Accuracy	100 µm
Gas Service	Oxygen, Air
Oxygen Concentration Adjustment Range	21% ~ 100%
Working Pressure	58 ~ 72.5 psi (4.5 ± 0.5 bar)
Working temperature	59 ~ 77°F (20 ± 5°C)
Relative Humidity	10% ~ 95%
Maximum Flow	140 LPM (Oxygen Concentration: 60%)



Clip Mount

- Easily mounted with the mounting bracket

Air Inlet

- USA standard: CGA V-5 1160 (DISS) air connector
- ISO standard: ISO 5359 A3 (NIST) air connector
- Compatible with GENTEC® medical hose assemblies

Outlet

- CGA V-5 1240 (DISS) connector
- With check valve
- Compatible with GENTEC® flowmeter

Oxygen Inlet

- USA standard: CGA V-5 1240 (DISS) oxygen connector
- ISO standard: ISO 5359 A8 (NIST) oxygen connector
- Compatible with GENTEC® medical hose assemblies

Ordering Information

FMX20	E	-	O	-	70	A	-	50	NS	-	DS	3	D20
Model Number	Color Code		Gas Code		Flow Rate	Gas Code		Flow Rate	Default Connections		Inlet Connection	Hose Length	Clip
FMX20	U: NFPA 99 (USA) E: ISO 32		O: Oxygen		70: 70 LPM 50: 50 LPM 30: 30 LPM 15: 15 LPM	A: Air		70: 70 LPM 50: 50 LPM 30: 30 LPM 15: 15 LPM	Null: Default Connections* DS: ISO Color Code with DISS Inlet Connector NS: NFPA 99 Color Code with NIST Inlet Connector		DS: DISS Connector NS: NIST Connector	3: 3 M 3: 5 M	Null: None D20: Φ8~20 Rod D30: Φ10~30 Rod S25: 25X10 Rail
<p>* Default connections for "E" ISO 32 color code uses NIST inlet connection and default connections for "U" NFPA 99 color code uses DISS inlet connection</p>													

OXYGEN THERAPY

Portable Oxygen Kit, Cylinder Valves, Refilling Bridge, Cylinder Wrench

Solutions for Life

Portable Oxygen Kit

- Portable oxygen kit is the perfect solution for outdoor activities
- Includes a small aluminum oxygen cylinder with a 284M oxygen regulator, nasal oxygen tube, and carrying bag



Model Number	Delivery Pressure	Liters	Weight	Working Hours
GMK-2.5	50 psi	2.5L	11 lbs	2 h

Cylinder Valves

GMV-870T GMV-870W GMV-965W GMV-CGA540



Model Number	Inlet Connection	Outlet Connection
GMV-870T	3/4"-16UNF	CGA870
GMV-870W	3/4"-16UNF	CGA870
GMV-965W	3/4"-16UNF	CGA965
GMV-CGA540	3/4"-16UNF	CGA540

Note: Please contact Genstar Technologies Company, Inc. for more information.

Refilling Bridge

- Fill gas to small cylinders



CRB-CGA540-CGA870
Refilling Bridge with CGA540 Inlet Connection, CGA870 Outlet Connection

Cylinder Wrench CGA 870



27-MCW870



Aluminum Cylinders



Model Number	Mfg No.	Oxygen Cubic ft.	Capacity Liters*	Outer Diameter		Height		Empty Weight	
				in	mm	in	mm	lb	kg
CYLM4-8T	M4	4	113	3	76.2	9	228.6	1.6	0.7
CYLM6-8T	M6	5.8	164.5	3.21	81.41	11.8	299	2.2	1
CYLM6A-8T	M6A	6	171.1	4.38	111.13	7.8	198.12	2.8	1.3
CYLM9-8T	M9 "C"	8.8	248.4	4.38	111.13	10.6	270	3.7	1.7
CYLM9-8T	MD "D"	14.6	414.6	4.38	111.13	16.2	411.2	4.9	2.2
CYLMJD-8T	JD	22.9	647.1	5.25	133.35	17.1	435.1	8.9	4
CYLM9-8T	E	24.1	682.2	4.38	111.13	25.2	639.8	7.3	3.3
CYLM60-8T	M60	60.9	1723.6	7.5	184.15	23.5	569.9	22.5	10.2
CYLM9-8T	MM	121.9	3452.5	8	203.2	36.3	922.3	40	18.1

Carbon Composite Cylinders

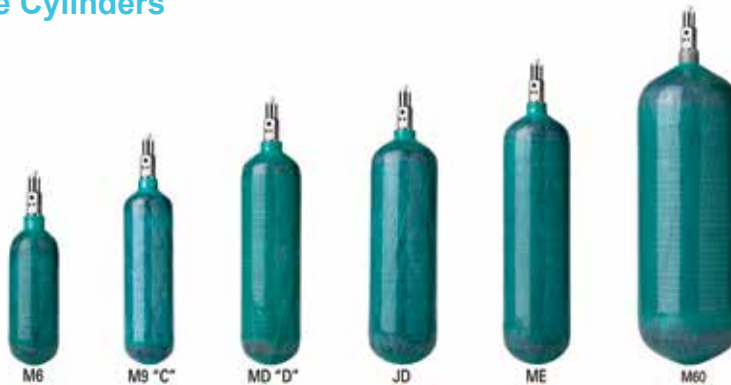

Model Number	Mfg No.	Oxygen Cubic ft.	Capacity Liters*	Outer Diameter		Height		Empty Weight	
				in	mm	in	mm	lb	kg
CMCM6-8T	M6	6.4	183	3.3	85	9.9	251	1.5	0.7
CMCM9-8T	M9 "C"	8.6	244	3.3	84	12.2	310	1.7	0.8
CMCMD-8T	MD "D"	15.4	437	4	10	14.7	373	2.9	1.3
CMCJD-8T	JD	21.6	616	4.5	114	15.5	394	3.3	1.5
CMCME-8T	ME	24.1	687	4.5	114	17.2	437	3.7	1.7
CMCM60-8T	M60	66	1867	6.8	172	20.7	526	9.3	4.2

*Approximate gaseous liters when calculated with 2000 psi pressure in cylinder for oxygen

OXYGEN THERAPY

Medical Hoses

Solutions for Life

Medical Hoses

Features

- Available in a variety of gases
- Available in USA and ISO colors
- Complies to ISO 5359 Standard
- Maximum working pressure: 200 psi
- Length: 100 m



34E-Green



34E-White



34E-Yellow



34E-Blue



34E-Grey



35E-Purple



34E-Black



35E-Rose

Ordering Information

Model	Standard	Color	NFPA 99 Color Service	ISO Color Service
34E-Green	1/4"	Green	Oxygen	/
34E-White	1/4"	White	/	Oxygen
34E-Yellow	1/4"	Yellow	Medical Air	/
34E-Blue	1/4"	Blue	Nitrous Oxide	Nitrous Oxide
34E-Grey	1/4"	Grey	Carbon Dioxide	Carbon Dioxide
34E-Black	1/4"	Black	Nitrogen	Nitrogen
34E-Black+White	1/4"	White+Black	/	Medical Air
35E-White	5/16"	White	Vacuum	/
35E-Yellow	5/16"	Yellow	/	Vacuum
35E-Rose	5/16"	Magenta Rose	/	AGSS
35E-Purple	5/16"	Purple	WAGD	/

Medical Hoses with Adapters

Features

- Designed for centralized medical gas distribution in hospitals, operating rooms, dental offices and clinics
- Connector: Ohmeda, DISS, Chemetron, Puritan-Bennett, French AFNOR, German DIN, British BS, Japanese JIS, Australian SIS
- Maximum working pressure: 200 psi
- Connector is made by brass or stainless steel
- Available in custom lengths and configurations add the length required with "-xx"

example: For a 1/4" green medical hose with ohmeda adapter (male) and DISS Hand-Tight adapter (male), Oxygen with a 10 Meter hose
 Mode number: 34U-OXY-OH-DH-10



Ordering Information

Ex: 34	U	- OXY	- OH / DS	- 3	
Hose	Color Code	Gas Code	Inlet / Outlet Connection	Hose Length	
34: 1/4" 35: 5/16"	U: USA standard I: ISO standard	OXY: Oxygen VAC: Vacuum AIR: Medical Air N2O: Nitrous Oxide WAGD: WAGD CO2: Carbon Dioxide N2: Nitrogen A8: Instrument Air	OH: Ohmeda® adapter (male) DS: DISS Hex adapter (male) DH: DISS Hand-Tight adapter (male) NS: NIST adapter CH: Chemetron® adapter (male) PB: Puritan-Bennett® adapter (male) FS: French (NF S 90-116) adapter (male) GS: German (DIN 13260-2) adapter (male), chrome-plated brass, 180° GSH: German (DIN 13260-2) adapter (male), stainless steel, 90° GSS: German (DIN 13260-2) adapter (male), stainless steel, 135° BS: British (BS5682-1998) adapter (male) JIS: Japanese Style adapter (male) SIS: Australian (AS2896) adapter (male)	FOH: Ohmeda® coupler (female) FDS: DISS Hex coupler (female) FDH: DISS Hand-Tight coupler (female) FNS: NIST adapter (female) FGS: German (DIN 13260-2) coupler (female) FBS: British (BS5682-1998) coupler (female) FJIS: Japanese Style coupler (female) FSIS: Australian (AS2896) coupler (female) Leave blank for no adapters	0.5: 0.5 m 1: 1 m 1.5: 1.5 m 2: 2 m 2.5: 2.5 m 3: 3 m 3.5: 3.5 m 4: 4 m 4.5: 4.5 m 5: 5 m 5.5: 5.5 m 6: 6 m

Special lengths can be ordered.

OXYGEN THERAPY

Medical Gas Adapters

























Solutions for Life

Medical Gas Adapters







Features

- Medical gas adapters are for use to connect medical gas devices to medical gas terminals.
- Suitable for medical gas and vacuum (negative pressure)
- Adapter material is chrome-plated brass or stainless steel
- Gas specific adapters

Ohmeda® Adapters

Ohmeda®					
USA Standard	Oxygen	Vacuum	Medical Air	Nitrous Oxide	WAGD
1/8" NPT	 3111U-OXY-NT2	 3111U-VAC-NT2	 3111U-AIR-NT2	 3111E-N2O-NT2	 3111U-WAG-NT2
1/4" or 5/16" Hose Barb	 3111U-OXY-HB4	 3111U-VAC-HB5	 3111U-AIR-HB4	 3111E-N2O-HB4	 3111U-WAG-HB4
ISO Standard	Oxygen	Vacuum	Medical Air	Nitrous Oxide	WAGD
1/8" NPT	 3111E-OXY-NT2	 3111E-VAC-NT2	 3111E-AIR-NT2	 3111E-N2O-NT2	
1/4" or 5/16" Hose Barb	 3111E-OXY-HB4	 3111E-VAC-HB5	 3111E-AIR-HB4	 3111E-N2O-HB4	 3111E-WAGD-HB5















Chemetron® Adapters

Chemetron®					
USA Standard	Oxygen	Vacuum	Medical Air	Nitrous Oxide	WAGD
1/8" NPT	 3103-OXY-NT2	 3103-VAC-NT2	 3103-AIR-NT2	 3103-N2O-NT2	 3103-WAG-NT2
ISO Standard	Oxygen	Vacuum	Medical Air	Nitrous Oxide	
	 3103E-OXY-NT2	 3103E-VAC-NT2	 3103E-AIR-NT2	 3103-N2O-NT2	

























Note: If the panel is too large, you cannot directly use the machine lock. The HB need use NT2 + FNT2-HB.

Medical Gas Adapters

Puritan-Bennett® Adapters

Puritan Bennett®					
	Oxygen	Vacuum	Medical Air	Nitrous Oxide	WAGD
1/8" NPT					
Chrome-plated Brass	3104-OXY-NT2	3104-VAC-NT2	3104-AIR-NT2	3104-N2O-NT2	3104-WAG-NT2
Stainless Steel	3114-OXY-NT2	3114-VAC-NT2	3114-AIR-NT2	3114-N2O-NT2	3114-WAG-NT2
1/4" or 5/16" Hose Barb					
Chrome-plated Brass	3104-OXY-HB4	3104-VAC-HB5	3104-AIR-HB4	3104-N2O-HB4	3104-WAG-HB5
Stainless Steel	3114-OXY-HB4	3114-VAC-HB5	3114-AIR-HB4	3114-N2O-HB4	3114-WAGD-HB5

DISS Hex Adapters

DISS Hex				
	Oxygen	Vacuum	Medical Air	Nitrous Oxide
1/8" NPT				
	3102-OXY-NT2	3102-VAC-NT2	3102-AIR-NT2	3102-N2O-NT2
1/4" or 5/16" Hose Barb				
	3102L-OXY-HB4	3102L-VAC-HB5	3102L-AIR-HB4	3102L-N2O-HB4
DISS Hex				
	WAGD	Carbon Dioxide	Nitrogen	Instrument Air
1/8" NPT				
	3102-WAG-NT2	3102-CO2-NT2	3102-NIT-NT2	3102-IA-NT2
1/4" or 5/16" Hose Barb				
	3102L-WAGD-HB5	3102L-CO2-HB4	3102L-NIT-HB4	3102L-IA-HB4

























OXYGEN THERAPY

Medical Gas Adapters

























Solutions for Life

Medical Gas Adapters

DISS Hand-Tight Adapters (USA Standard)







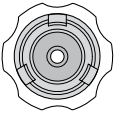
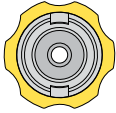
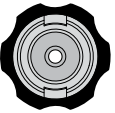
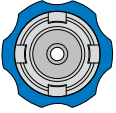

DISS Hand-Tight				
USA Standard	Oxygen	Vacuum	Medical Air	Nitrous Oxide
1/8" NPT	 3222-OXY-NT2	 3222U-VAC-NT2	 3222U-AIR-NT2	 3222E-N2O-NT2
1/4" or 5/16" Hose Barb	 3222-OXY-HB4	 3222U-VAC-HB5(wh)	 3222U-AIR-HB4	 3222E-N2O-HB4
DISS Hand-Tight				
USA Standard	WAGD	Carbon Dioxide	Nitrogen	Instrument Air
1/8" NPT	 3222-WAG-NT2	 3222E-CO2-NT2	 3222E-NIT-NT2	 3222-IA-NT2
1/4" or 5/16" Hose Barb	 3222-WAG-HB5	 3222E-CO2-HB4	 3222E-NIT-HB4	 3222-IA-HB4

DISS Hand-Tight Adapters (ISO Standard)













DISS Hand-Tight				
ISO Standard	Oxygen	Vacuum	Medical Air	Nitrous Oxide
1/8" NPT	 3222E-OXY-NT2	 3222E-VAC-NT2	 3222E-AIR-NT2	 3222E-N2O-NT2
1/4" or 5/16" Hose Barb	 3222E-OXY-HB4	 3222E-VAC-HB5	 3222E-AIR-HB4	 3222E-N2O-HB4
DISS Hand-Tight				
ISO Standard	WAGD	Carbon Dioxide	Nitrogen	Instrument Air
1/8" NPT	 3222E-WAG-NT2	 3222E-CO2-NT2	 3222E-NIT-NT2	 3222-IA-NT2
1/4" or 5/16" Hose Barb	 3222E-WAG-HB5	 3222E-CO2-HB4	 3222E-NIT-HB4	 3222-IA-HB4

Medical Gas Adapters







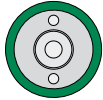
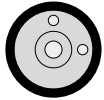
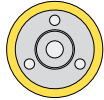
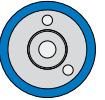

French Standard

FS				
	Oxygen	Vacuum	Medical Air	Nitrous Oxide
1/8" NPT	 3105E-O-NT2	 3105E-V-NT2	 3105E-A-NT2	 3105E-2-NT2
1/4" or 5/16" Hose Barb	 3105E-O-HB4	 3105E-V-HB5	 3105E-A-HB4	 3105E-2-HB4

Australian Standard

SIS				
	Oxygen	Vacuum	Medical Air	Nitrous Oxide
1/8" NPT	 3209E-OXY-NT2	 3209E-VAC-NT2	 3209E-AIR-NT2	 3209E-N2O-NT2
1/4" or 5/16" Hose Barb	 3209E-OXY-HB4	 3209E-VAC-HB5	 3209E-AIR-HB4	 3209E-N2O-HB4

Japanese Standard

JIS				
	Oxygen	Vacuum	Medical Air	Nitrous Oxide
1/8" NPT	 3108-OXY-NT2	 3108-VAC-NT2	 3108-AIR-NT2	 3108-N2O-NT2
1/4" or 5/16" Hose Barb	 3108-OXY-HB4H	 3108-VAC-HB5H	 3108-AIR-HB4H	 3108-N2O-HB4H



































OXYGEN THERAPY

Medical Gas Adapters





















Solutions for Life

Medical Gas Adapters





DIN German Standard

GS							
	Oxygen	Vacuum	Medical Air	Nitrous Oxide	Carbon Dioxide	Nitrogen	Instrument Air
1/8" NPT							
Chrome-plated Brass	3106-OXY-NT2	3106-VAC-NT2	3106-AIR-NT2	3106-N2O-NT2	3106-CO2-NT2	3106-N2-NT2	3106-MA7-NT2
Stainless Steel	3116-OXY-NT2	3116-VAC-NT2	3116-AIR-NT2	3116-N2O-NT2	3116-CO2-NT2	3116-N2-NT2	3116-MA7-NT2
1/4" or 5/16" Hose Barb (180°)							
Chrome-plated Brass	3106-OXY-HB4	3106-VAC-HB5	3106-AIR-HB4	3106-N2O-HB4	3106-CO2-HB4	3106-N2-HB4	3106-MA7-HB4
1/4" or 5/16" Hose Barb (135°)							
Stainless Steel	3116-OXY-HB4	3116-VAC-HB5	3116-AIR-HB4	3116-N2O-HB4	3116-CO2-HB4	3116-N2-HB4	3116-MA7-HB4
1/4" or 5/16" Hose Barb (90°)							
Stainless Steel	3116-OXY-HB4H	3116-VAC-HB5H	3116-AIR-HB4H	3116-N2O-HB4H	3116-CO2-HB4H	3116-NIT-HB4H	3116-MA7-HB4H

British Standard













BS							
	Oxygen	Vacuum	Medical Air	Nitrous Oxide	Carbon Dioxide	Nitrogen	Instrument Air
1/8" NPT							
Stainless Steel	3117-OXY-NT2	3117-VAC-NT2	3117-AIR-NT2	3117-N2O-NT2	3117-CO2-NT2	3117-N2-NT2	3117-MA7-NT2
1/4" or 5/16" Hose Barb							
Stainless Steel	3117-OXY-HB4	3117-VAC-HB5	3117-AIR-HB4	3117-N2O-HB4	3117-CO2-HB4	3117-N2-HB4	3117-MA7-HB4

Scandinavian Standard

















AGA	Oxygen	Medical Air
1/8" NPT		
Stainless Steel	AGA-OXY-NT2	AGA-AIR-NT2
1/4" Hose Barb		
Stainless Steel	AGA-OXY-HB4	AGA-AIR-HB4

Medical Gas Adapters

DISS Adapter with Check Valve

DISS	Oxygen	Vacuum	Medical Air	Nitrous Oxide
1/8" or 1/4" NPT	 DISS-OXY-NT2(NT4)	 DISS-VAC-NT2(NT4)	 DISS-AIR-NT2(NT4)	 DISS-N2O-NT2(NT4)
1/8" or 1/4" NPT with Check Valve	 DISS-OXY-NT2(NT4)/CHK	 DISS-VAC-NT2(NT4)/CHK	 DISS-AIR-NT2(NT4)/CHK	 DISS-N2O-NT2(NT4)/CHK
1/4" or 5/16" Hose Barb	 DISS-OXY-HB4	 DISS-VAC-HB5	 DISS-AIR-HB4	 DISS-N2O-HB4

NIST / FNIST Adapter with Check Valve

NIST	Oxygen	Vacuum	Medical Air	Nitrous Oxide
1/4" or 5/16" Hose Barb	 NIST-OXY-HB4	 NIST-VAC-HB5	 NIST-AIR-HB4	 NIST-N2O-HB4
FNIST	Oxygen	Vacuum	Medical Air	Nitrous Oxide
1/8" or 1/4" NPT	 FNIST-OXY-NT2(NT4)	 FNIST-VAC-NT2(NT4)	 FNIST-AIR-NT2(NT4)	 FNIST-N2O-NT2(NT4)
1/8" or 1/4" NPT with Check Valve	 FNIST-OXY-NT2(NT4)/CHK	 FNIST-VAC-NT2(NT4)/CHK	 FNIST-AIR-NT2(NT4)/CHK	 FNIST-N2O-NT2(NT4)/CHK
1/4" or 5/16" Hose Barb	 FNIST-OXY-HB4	 FNIST-VAC-HB5	 FNIST-AIR-HB4	 FNIST-N2O-HB4









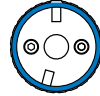

OXYGEN THERAPY

Couplers



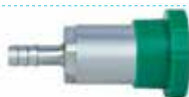





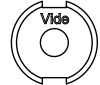

Solutions for Life

Couplers











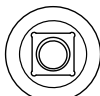



Ohmeda® Couplers

Ohmeda®				
USA Standard	Oxygen	Vacuum	Medical Air	Nitrous Oxide
1/8" NPT	 3911U-O-NT2	 3911U-V-NT2	 3911U-A-NT2	 3911U-2-NT2
1/4" or 5/16" Hose Barb	 3911U-O-HB4	 3911U-V-HB5	 3911U-A-HB4	 3911U-2-HB4

Afnor FS Couplers

















Afnor FS				
	Oxygen	Vacuum	Medical Air	Nitrous Oxide
1/8" NPT	 3915E-O-NT2	 3915E-V-NT2	 3915E-A-NT2	 3915E-2-NT2
1/4" or 5/16" Hose Barb	 3915E-O-HB4	 3915E-V-HB5	 3915E-A-HB4	 3915E-2-HB4

DIN Couplers

















DIN				
	Oxygen	Vacuum	Medical Air	Nitrous Oxide
1/8" NPT	 3916E-O-NT2S	 3916E-V-NT2S	 3916E-A-NT2S	 3916E-2-NT2S
1/4" or 5/16" Hose Barb	 3916E-O-HB4S	 3916E-V-HB5S	 3916E-A-HB4S	 3916E-2-HB4S
1/8" FNPT	 3916E-O-FNT2S	 3916E-V-FNT2S	 3916E-A-FNT2S	 3916E-2-FNT2S

Couplers









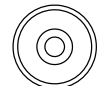

BS Couplers

BS				
	Oxygen	Vacuum	Medical Air	Nitrous Oxide
1/8" NPT	 3917E-O-NT2S	 3917E-V-NT2S	 3917E-A-NT2S	 3917E-2-NT2S
1/4" or 5/16" Hose Barb	 3917E-O-HB4S	 3917E-V-HB5S	 3917E-A-HB4S	 3917E-2-HB4S
1/8" FNPT	 3917E-O-FNT2S	 3917E-V-FNT2S	 3917E-A-FNT2S	 3917E-2-FNT2S

JIS Couplers

JIS				
	Oxygen	Vacuum	Medical Air	Nitrous Oxide
1/8" NPT	 3918E-O-NT2S	 3918E-V-NT2S	 3918E-A-NT2S	 3918E-2-NT2S
1/4" or 5/16" Hose Barb	 3918E-O-HB4S	 3918E-V-HB5S	 3918E-A-HB4S	 3918E-2-HB4S
1/8" FNPT	 3918E-O-FNT2S	 3918E-V-FNT2S	 3918E-A-FNT2S	 3918E-2-FNT2S

SIS Couplers

SIS				
	Oxygen	Vacuum	Medical Air	Nitrous Oxide
1/8" or 1/4" NPT with Check Valve	 3109M-OXY-NT2(NT4)/CHK	 3109M-VAC-NT2(NT4)/CHK	 3109M-AIR-NT2(NT4)/CHK	 3109M-N2O-NT2(NT4)/CHK
1/4" or 5/16" Hose Barb	 3109M-OXY-HB4/CHK	 3109M-VAC-HB5/CHK	 3109M-AIR-HB4/CHK	 3109M-N2O-HB4/CHK

OXYGEN THERAPY

Twin Coupler, Accessories

Solutions for Life

Twin Coupler

Twin Couplers are available in Ohmeda, British (BS), Australian (SIS), German (DIN), Japanese (SIS), and DISS configurations.



Accessories

Hose Barb Adapters

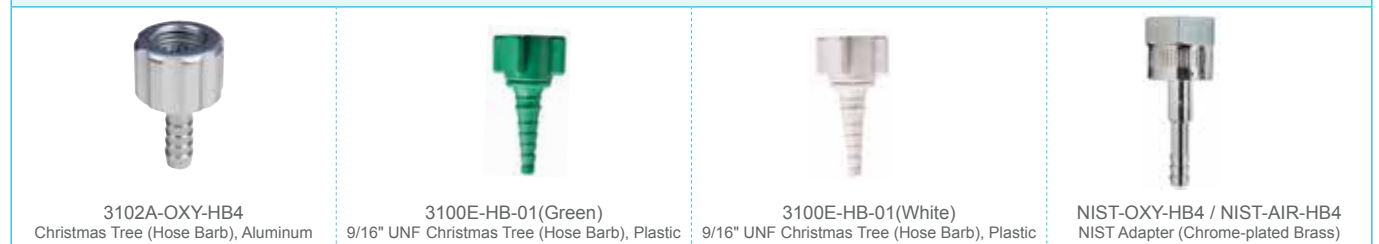

Convert Adapters



Others Adapters



88XVR Series Suction Regulators

Mode Selector Switch

- Clearly marked indicator
- GENTEC® suction regulators are available in continuous only (882 Series) and continuous-intermittent (881 Series)
- 160 mmHg and 200 mmHg are available in pediatric, 300 mmHg is available in adult, and 760 mmHg is available in surgical
- Factory default settings for INT (on / off) cycles on the 881 Series is 8 seconds off, 16 seconds on. On/off settings can be adjusted

Control Knob

- Easy adjustment of vacuum pressure
- No Leakage
- Agion® Antimicrobial protection
 - Built-in long lasting antimicrobial protection
 - Based on naturally-occurring silver
 - Inhibits growth of microbes on surface of knobs and switches
 - Environmentally friendly technology
 - Broad Regulatory Approvals including EPA, FDA, NSF, USDA, Canada, European BPD, Swiss and EFSA
- Color Coding available in both NFPA 99 and ISO 32 Color Code



Fittings

- GENTEC® provides a wide range of fittings to meet customers' needs



881VR-300-XX
Continuous / Intermittent
0~300 mmHg

Glow in The Dark Gauge

- 2-1/2" gauge, easy to read
- Color coded flow ranges
- Dual Scale mmHg and kPa
- Clockwise, counter-clockwise or digital gauge mode (features an analog scale in digital mode where a digital reading is on screen and an analog meter on the outer ring)



Cover

- High-quality ABS case body for long durability
- Impact-resistant internal components minimize damage if regulator is bumped or dropped
- Easy to clean, wipe down with sterilant

Interior Structure

- Few mechanical parts for easy maintenance
- Corrosion free
- Lightweight

Suction Trap

- Prevents contamination caused by overflow

















* Agion's silver antimicrobial has been certified for its material content, recyclability, and manufacturing characteristics. Cradle To Cradle CertifiedCM products meet established standards for human health, environmental health and recyclability. Cradle To Cradle Certified CM is a certification mark of MBDC.

SUCTION THERAPY

Suction Regulators

Solutions for Life

Technical Specification

	881VR Series Continuous / Intermittent			882VR Series Continuous-only			
Clockwise	 881VR-160 pediatric	 881VR-200 adult	 881VR-300 adult	 882VR-160 pediatric	 882VR-200 adult	 882VR-300 adult	 882VR-760 surgical
Counter-Clockwise	 881VR-160E pediatric		 881VR-300E adult	 882VR-160E adult		 882VR-300E adult	 882VR-760E surgical
Digital Gauge	 881VR-160D pediatric		 881VR-300D adult	 882VR-160D pediatric		 882VR-300D adult	 882VR-760D surgical
Mode Selection:							
OFF	√	√	√	√	√	√	√
CONT	√	√	√	√	√	√	√
INT	√	√	√	X	X	X	X
FULL	X	X	X	X	√	√	√
Regulated Vacuum Range	0~160 mmHg	0~200 mmHg	0~300 mmHg	0~160 mmHg	0~200 mmHg	0~300 mmHg	0~760 mmHg
Gauge Display Range	0~160 mmHg	0~200 mmHg	0~300 mmHg	0~160 mmHg	0~200 mmHg	0~300 mmHg	0~760 mmHg
Gauge Accuracy	± 4%	± 4%	± 4%	± 4%	± 4%	± 4%	± 4%
Intermittent Time	Suction: 16 seconds, Stop: 8 seconds			/	/	/	/
Flow Rate	>50 l/min (CONT) 7-9 l/min (INT)	>55 l/min (CONT) 7-9 l/min (INT)	>60 l/min (CONT) 7-9 l/min (INT)	>50 l/min	>55 l/min	>60 l/min	>70 l/min
Weight	1 lb / 0.455 kg			0.81 lb / 0.37 kg			
Dimensions	6.3" H × 3.15" W × 3.94" D / 16 × 8 × 10 cm			6.3" H × 3.15" W × 3.94" D / 16 × 8 × 10 cm			

Ordering Information



00	OH	DH	DS	CH	PB
 No Adapter 1/8" NPT (F)	 Ohmeda® 3111-VAC-NT2	 DISS Hand-tight 3222-VAC-NT2	 DISS Hex 3102-VAC-NT2	 Chemetron® 3103-VAC-NT2	 Puritan-Bennett® 3114-VAC-NT2
FS	GS	BS	JIS	SIS	
 3105-VAC-NT2	 3116-VAC-NT2	 3117-VAC-NT2	 3108-VAC-NT2	 3209-VAC-NT2	

A	T	B	C	D
 No Adapter 1/8" NPT (F)	 Suction Trap Assembly (Complete)	 Trap Fitting Only (No Trap)	 DISS Male Vacuum	 Tubing Nipple (5/16" Hose Barb)

Ex: 881VR	- 300	E	- 00	- T
Series	Vacuum Range	Gauge	Vacuum Connection	Suction Connection
881VR 882VR	160: 0~160 mmHg 200: 0~200 mmHg (only for clockwise) 300: 0~300 mmHg 760: 0~760 mmHg	None: Clockwise E: Counter-Clockwise D: Digital Gauge	00: No adapter, 1/8" NPT (F) OH: Ohmeda® adapter (male) DH: DISS Hand-Tight adapter (male) DS: DISS Hex adapter (male) CH: Chemetron® adapter (male) PB: Puritan-Bennett® adapter (male) FS: French (NF S 90-116) adapter (male) GS: German (DIN 13260-2) adapter (male) BS: British (BS5682-1998) adapter (male) JIS: Japanese Style adapter (male) SIS: Australian (AS2896) adapter (male)	A: No adapter, 1/8" NPT (F) T: Suction trap assembly (complete) B: Trap fitting only (No trap) C: DISS male vacuum D: Tubing nipple (5/16" hose bbarb)

SUCTION THERAPY

Venturi Suction Regulator

Solutions for Life

880VS Series Venturi Suction Regulator



Glow in The Dark Gauge

- 2" gauge, easy to read
- Color coded flow ranges
- Dual Scale mmHg and kPa

Safety Device

- Positive pressure relief valve provides safe use
- ISO 10079-3 Compliant

Control Knob

- Easy adjustment of vacuum pressure
- No Leakage

Suction Connector

- GENTEC® provides a wide range of fittings to meet customers' needs

Suction Trap

- Prevents contamination caused by overflow

Type of Adapter

- None: Without adapter
- OH: Ohmeda® adapter
- DS: DISS Hex adapter
- DH: DISS Hand-Tight adapter
- CH: Chemetron® adapter
- PB: Puritan-Bennett® adapter
- FS: French (NF S 90-116) adapter
- GS: German (DIN 13260-2) adapter
- BS: British (BS5682-1998) adapter
- JIS: Japanese Style adapter
- SIS: Australian (AS2896) adapter

Venturi Suction

- Delivers steady and high vacuum flow from a medical air or oxygen gas source
- Control Range: -1 kPa ~ -80 kPa

Technical Specification

Dimension (H x W x D)	90 x 90 x 60 mm
Weight	490 g
Range	-1 kPa ~ -80 kPa
Maximum Suction	> 25 L / min
Source of Pressure	300 ~ 500 kPa
Vacuum Control	Needle valve control venturi
Vacuum Gauge Range	0 ~ -100 kPa / 0 ~ 760 mmHg

880VS-760-00-A-T



SUCTION THERAPY









Solutions for Life

Venturi Suction Regulator

Ordering Information



00	OH	DH	DS	CH	PB
 No Adapter 1/8" NPT (F)	 Ohmeda® 3111-OXY-NT2 3111-AIR-NT2	 DISS Hand-tight 3222-OXY-NT2 3222-AIR-NT2	 DISS Hex 3102-OXY-NT2 3102-AIR-NT2	 Chemetron® 3103-OXY-NT2 3103-AIR-NT2	 Puritan-Bennett® 3114-OXY-NT2 3114-AIR-NT2
FS	GS	BS	JIS	SIS	OE
 FS 3105-OXY-NT2 3105-AIR-NT2	 GS 3116-OXY-NT2 3116-AIR-NT2	 BS 3117-OXY-NT2 3117-AIR-NT2	 JIS 3108-OXY-NT2 3108-AIR-NT2	 SIS 3209-OXY-NT2 3209-AIR-NT2	 OE Oxyquip Air 3301-AIR-NT2

A	T	TD	TH	H	D	N	F
 No Adapter 1/8" NPT (F)	 Suction Trap Assembly (Complete)	 Suction Trap (with DISS female nut & nipple vacuum fitting)	 Suction Trap (with DISS female vacuum hand-tight)	 Tubing Nipple (5/16" Hose Barb)	 DISS Male Vacuum	 NIST vacuum fitting	 Trap Fitting Only (No Trap)

Series	Measuring Range	Oxygen / Air Connection	Driving Gas	Suction Connection
880VS	760: 0-760 mmHg	00: No adapter, 1/8" NPT (F) OH: Ohmeda® adapter (male) DH: DISS Hand-Tight adapter (male) DS: DISS Hex adapter (male) CH: Chemetron® adapter (male) PB: Puritan-Bennett® adapter (male) FS: French (NF S 90-116) adapter (male) GS: German (DIN 13260-2) adapter (male) BS: British (BS5682-1998) adapter (male) JIS: Japanese Style adapter (male) SIS: Australian (AS2896) adapter (male) OE: Oxyquip air adapter	A: Medical Air O: Oxygen	00: No adapter, 1/8" NPT (F) T: With suction trap assembly (complete) TD: With suction trap (complete DISS female nut) TH: With suction trap (complete DISS female vacuum hand-tight) H: With tubing nipple (5/16" hose barb) D: With DISS male vacuum N: With NIST adapter F: With trap fitting only (no trap)

SUCTION THERAPY

Venturi Actuated Suction

Solutions for Life

POWER-VAC 880VC Series Venturi Actuated Suction Device

Power-Vac 880VC Series is a venturi actuated suction device which features two power take-off connectors for connecting oxygen sources. It can be used in hospital treatments, powering devices, life support, and any circumstances where patients require the assistant of oxygen or suction therapy. The device can be connected to a central oxygen pipeline outlet or cylinder regulator with a pre-set outlet pressure.

Dual Scale

- 2" gauge, easy to read
- -100 ~ 0 kPa and -760 ~ 0 mmHg scale
- Color coded pressure gauge and identification labels



Type of Adapter

- None: Without adapter
- OH: Ohmeda® adapter
- DS: DISS Hex adapter
- DH: DISS Hand-Tight adapter
- CH: Chemetron® adapter
- PB: Puritan-Bennett® adapter
- FS: French (NF S 90-116) adapter
- GS: German (DIN 13260-2) adapter
- BS: British (BS5682-1998) adapter
- JIS: Japanese Style adapter
- SIS: Australian (AS2896) adapter

Highly Compatible

- Internationally recognized SIS (AS2896) or DISS (CGA V-5) adapters

Power Take-Offs

- Provides dual oxygen connectors for oxygen therapy applications

Suction Trap

- Prevents contamination caused by overflow

Suction Connector

- GENTEC® provides a wide range of fittings to meet customers' needs











880VC-760-SIS-T



Ordering Information



00	OH	DH	DS	CH	PB
 No Adapter 1/8" NPT (F)	 Ohmeda® 3111-OXY-NT2 3111-AIR-NT2	 DISS Hand-tight 3222-OXY-NT2 3222-AIR-NT2	 DISS Hex 3102-OXY-NT2 3102-AIR-NT2	 Chemetron® 3103-OXY-NT2 3103-AIR-NT2	 Puritan-Bennett® 3114-OXY-NT2 3114-AIR-NT2
FS	GS	BS	JIS	SIS	OE
 FS 3105-OXY-NT2 3105-AIR-NT2	 GS 3116-OXY-NT2 3116-AIR-NT2	 BS 3117-OXY-NT2 3117-AIR-NT2	 JIS 3108-OXY-NT2 3108-AIR-NT2	 SIS 3209-OXY-NT2 3209-AIR-NT2	 OE Oxyquip Air 3301-AIR-NT2

A	T	TD	TH	H	D	N	F
 No Adapter 1/8" NPT (F)	 Suction Trap Assembly (Complete)	 Suction Trap (with DISS female nut & nipple vacuum fitting)	 Suction Trap (with DISS female vacuum hand-tight)	 Tubing Nipple (5/16" Hose Barb)	 DISS Male Vacuum	 NIST vacuum fitting	 Trap Fitting Only (No Trap)

Series	Measuring Range	Oxygen / Air Connection	Driving Gas	Suction Connection
880VC	760: 0-760 mmHg	00: No adapter, 1/8" NPT (F) OH: Ohmeda® adapter (male) DH: DISS Hand-Tight adapter (male) DS: DISS Hex adapter (male) CH: Chemetron® adapter (male) PB: Puritan-Bennett® adapter (male) FS: French (NF S 90-116) adapter (male) GS: German (DIN 13260-2) adapter (male) BS: British (BS5682-1998) adapter (male) JIS: Japanese Style adapter (male) SIS: Australian (AS2896) adapter (male) OE: Oxyquip air adapter	A: Medical Air O: Oxygen	00: No adapter, 1/8" NPT (F) T: With suction trap assembly (complete) TD: With suction trap (complete DISS female nut) TH: With suction trap (complete DISS female vacuum hand-tight) H: With tubing nipple (5/16" hose barb) D: With DISS male vacuum N: With NIST adapter F: With trap fitting only (no trap) 1L: With SJ series reusable jars, 1L

SUCTION THERAPY

Venturi System, Venturi Vacuum Modules

Solutions for Life

Venturi System



Ordering Information

Ex: 881VG	- 300	E	- A	- 00	- T
Series	Measuring Range	Pointer Rotate Mode	Driving Gas	Vacuum Connection	Suction Connection
881VG 882VG	160: 0~160 mmHg 200: 0~200 mmHg 300: 0~300 mmHg 760: 0~760 mmHg (only for 882VG)	None: Clockwise (USA) E: Counter-clockwise (ISO)	A: Air O: Oxygen	00: No adapter 1/8" NPT (F) FDS: DISS hose barb (USA) FNS: NIST hose barb (ISO)	T: Suction trap assembly (complete) None: Without suction trap

Standard suction hose length is 0.5 m, for other length, please contact GENTEC.

Venturi Vacuum Modules



880VE-00/U

Features

- Designed to work with vacuum regulator
- Oxygen or Medical Air as gas source
- Small and compact
- With positive pressure relief valve
- With silencer
- Maximum vacuum: 0 ~ 600 mmHg
- Maximum air free flow: 30 L / min
- Noise: < 60 dBa

DL Series Disposable Collection Jars

Features

- Constructed with durable polyethylene material
- Used with polycarbonate reusable collection jars
- Liner can be easily disposed and replaced
- Tandem port for multiple canister connections
- Overflow protection and non-return valves prevent backflow
- Can be used with GENTEC® reusable collection jar
- Holds 1 or 2 liters
- Hose barb inlet and outlet



Ordering Information

DL-2000B(L)	DL-2000W(L)	DL-1000B(L)	DL-1000W(L)	615-901(L)	615-902	615-903	615-904	615-905
Liner with overflow protection, 2L	Liner without overflow protection, 2L	Liner with overflow protection, 1L	Liner without overflow protection, 1L	Collections Jar, 2L, reusable	Suction hose, ID 6.5mm, 0.35m with suction tip	Suction hose, ID 6.5mm, 2 m with suction tip	Suction hose, ID 6.5mm, 3 m with suction tip	Suction hose, ID 6.5mm, 10 m without suction tip

SUCTION THERAPY

Collection Jars

Solutions for Life



SJ Series Reusable Collection Jars

- 1 liter, 1.5 liter, and 2.5 liter models available
- The SJ-1000 series comes with a polycarbonate jar and anodized aluminum cover
- The SJ-1500 and SJ-2500 Series comes with polycarbonate jar and cover
- Built-in bracket for use with GENTEC® wall slides
- Polycarbonate jar for maximum durability
- Ball float design prevents overflow
- GENTEC® SJ series reusable canisters are manufactured to be durable and autoclavable (up to 121°C)

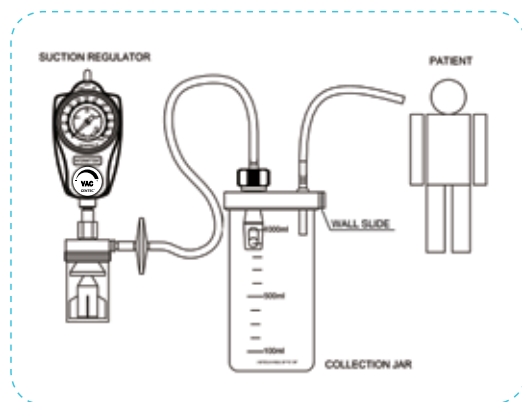

DJ Series Disposable Collection Jars

- 0.85 liter, 1 liter, and 2 liter models available
- comes with polycarbonate jar and cover
- Built-in bracket for use with GENTEC® wall slides
- Ball float design prevents overflow
- Hose barb inlet and outlet

Ordering Information

Model	SJ Series				DJ Series		
							
	SJ-1000A	SJ-1000B	SJ-1500*	SJ-2500*	DJ-850	DJ-1000	DJ-2000
Volume	1 L	1 L	1.5 L	2.5 L	0.85 L	1 L	2 L
Overfill Protection Devices	✓	✓	✓	✓	✓	✓	✓
Vacuum Connection	DISS	Hose Barb (Φ6-8)	Hose Barb (Φ6-8)	Hose Barb (Φ6-8)	Hose Barb (Φ6-8)	Hose Barb (Φ6-8)	Hose Barb (Φ6-8)
Patient Connection	Hose Barb (Φ6-8)						

* Add "-T" at the end of the model when ordering units without float trap for use in tandem

Wall Slides

- For use on all surfaces
- Fits GENTEC® DJ, SJ & DL series collection jars



SJ-CLP



CLP-D40-45
12~40mm



CLP-D30
10~30mm



3910-Sld



3820-Sld



Collection Stations

- Designed to support collection jars
- Stable 5-caster base with two locking casters
- Durable construction, easy to clean
- Supports up to 4 canisters
- Includes suction trap for additional safety
- Shut-off valve and canister slides included



810-00(DH) / 810-00(HB)



Suction Tubings

Model	Description
ST6-4	Suction Tubing 1/4" (6mm), I.D. 4 Meters, Without Suction Tip
ST6-100	Suction Tubing 1/4" (6mm), I.D. 100 Meters, Without Suction Tip
ST8-4	Suction Tubing 5/16" (8mm), I.D. 4 Meters, Without Suction Tip
ST8-160	Suction Tubing 5/16" (8mm), I.D. 160 Meters, Without Suction Tip



SUCTION THERAPY

Disposable Bacteria Filters

Solutions for Life

Disposable Bacteria Filters

Features

- Prevents contamination and fluid from entering the vacuum regulator and vacuum systems
- PVDF special filter material, can effectively filter the virus and bacteria
- Effective filtration area: 32 cm²
- Maximum operating temperature: 140 °F (60 °C)
- Maximum operating pressure: -14.5 ~ 14.5 psi
- Filters down to 0.22 micron



F11-HB



F11-NT2/HB



Dimensions

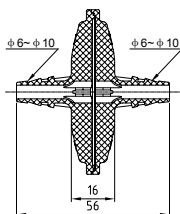
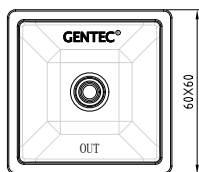

F11-HB

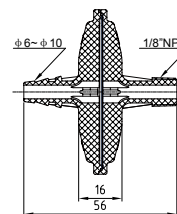
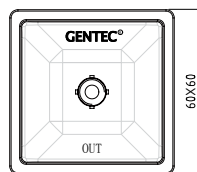
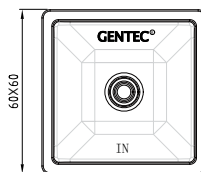

F11-NT2/HB

Ordering Information

Model	Description
F11-NT2/HB-0.45	Hydrophobic, Inlet: 1/4" Hose Barb, Outlet: 1/8" NPT, Filter Accuracy: 0.45µm
F11-HB-0.45	Hydrophobic, Inlet and Outlet: 1/4" Hose Barb, Filter Accuracy: 0.45µm



Medical Gas Systems & Devices Overview

- Medical Gas Systems Total Solution
- Source Equipment
- Zone Valve Box & Area Valve Service Unit
- Monitoring Alarm & Control System
- Art Wall Enclosure
- Medical Console Units
- Medical Gas Outlets
- Anaesthetic Gas Scavenging System
- Oxygen Therapy
- Suction Therapy
- Oxygen Concentrator & Nebulizers
- Respiratory Care



Medical Pipeline System

- Medical Manifold Systems
- Zone Valve Box
- Area Valve Service Unit
- Medical Gas Cocontrol Panel
- Medical Check Valves with Extensions
- Medical Alarm Systems
- Medical Art Wall Enclosure
- Medical Bedhead Units
- Medical Gas Outlets



Respiratory Care Series Products

- Air/Oxygen Blenders
- NebuCare In-line Electrical Nebulizer
- Portable Mesh-Sonic Nebulizer
- NebuSmart All-in-one Nebulizer
- Disposable Collection System
- Anesthesia / Breathing Circuits
- G-Smart Adult Test Lung
- Respire CPAP Mask

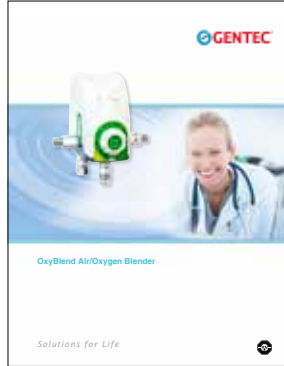

OxyBlend Air/Oxygen Blender

- OxyBlend Air/Oxygen Blender
- Accessories

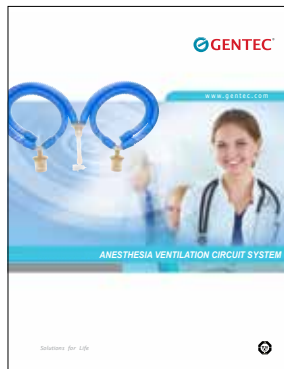

Anesthesia Ventilation Circuit System

- Anesthesia, Breathing Circuit for Adult
- Anesthesia, Breathing Circuit for Child
- Accessories



HIGH FLOW OXYGEN THERAPY

- Air/Oxygen Blenders GMX Series
- Disposable Breathing Circuit System
- Humification Chamber
- High Flow Nasal Cannula



Genstar Technologies Company Inc.

4525 Edison Avenue, Chino, CA 91710, USA

Tel: 909-606-2726

Fax: 909-606-6485

www.gentec.com

